

# automaticinserts

intelligent fire

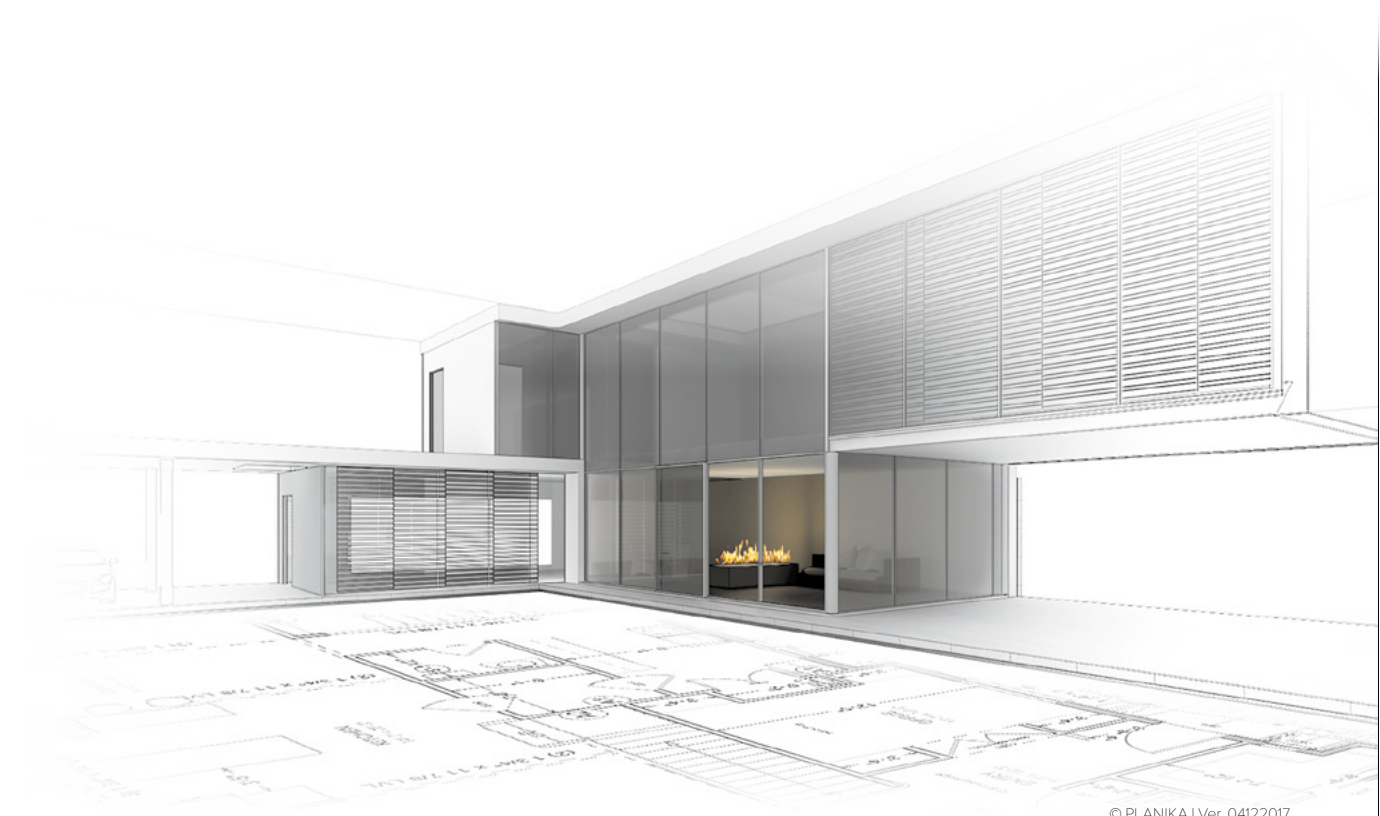

© PLANIKA | Ver. 04122017

# Fire Line Automatic 3 XL automatic inserts

## FLA3 XL

FLA with an eXtra Long burning time  
For those who value their comfort

### FEATURES:

- BEV\* Technology
- Automatic fuel pump
- Extra large fuel tank to extend burning time
- No smell/no ash/no smoke
- WiFi controllable
- Remote controllable
- Smart Home Systems compatible
- Advanced safety sensors
- Fast Start
- Automatic shutdown in case of errors
- Child Lock
- Sleep timer
- Advanced microprocessor
- LCD display
- Control panel
- Intuitive control
- 6 levels of flame height
- Easy installation
- Possibility of joining modules
- No additional installation
- No additional ventilation required
- No chimney required
- External wireless temperature sensor
- Electrical connection required
- For indoor use
- Eco-friendly
- Certified

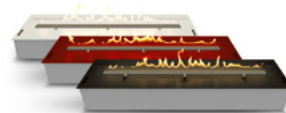
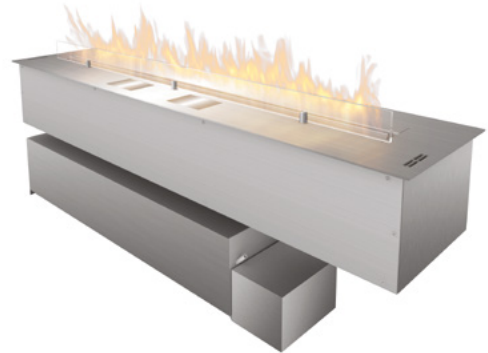

### DIMENSIONS:

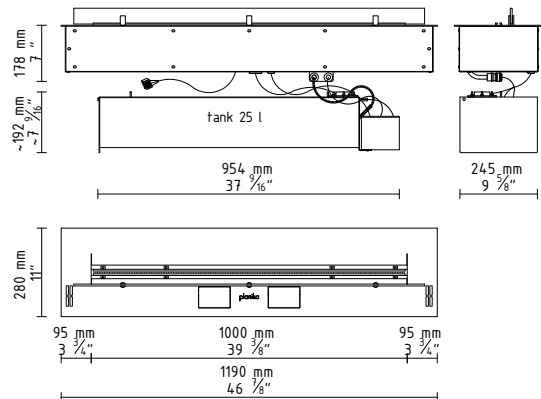

\* BEV Technology – A patented process resulting in the clean burning of bio-ethanol fuel vapours.

### TECHNICAL DATA:

Capacity: 25 L / [US] 6,6 gal / [UK] 5,5 gal

Burning time: 17 - 42 h

Heat output: 3,3 - 8,4 kW / 11398 - 28490 BTU

Net weight: 36,5kg / 80 lbs

Air circulation: min. 1/h

Minimum room size:

please contact our Project Department for details

Power supply: 230 V / 115 V

Finish:

TOP: brushed stainless steel / optional: RAL colours / optional: black powder coated steel,

CASING: galvanized steel,

GLASS SHIELD: tempered glass

### INSTALLATION:

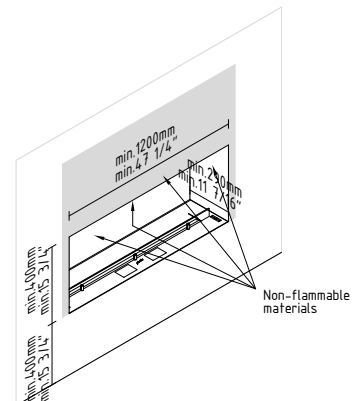

# Fire Line Automatic 3 XL automatic inserts

FLA3 XL

## BESPOKE MODELS:

Planika ensures top service. To live up to our clients' requirements, we have provided the possibility to produce bespoke models, according to the client's expectations. Length of the bio fireplace is customizable.

## SEVERAL JOINT UNITS - UP TO UNLIMITED LENGTH:

If a longer line of fire is preferred, several units can be placed together and operated with a single remote control, giving the possibility to create an endless line of fire. Client can choose between the right, middle and left module.

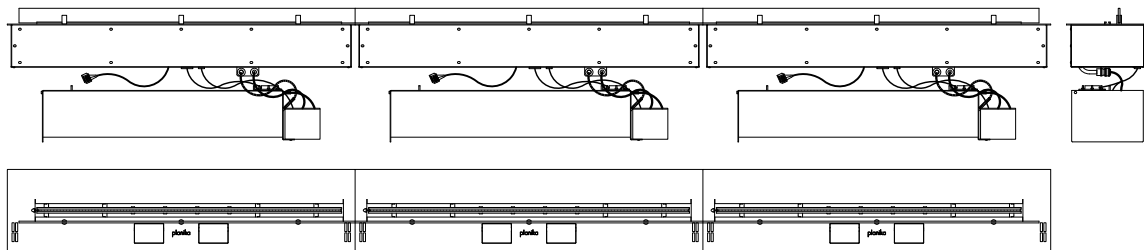

## INDOOR INSTALLATION REQUIREMENTS:

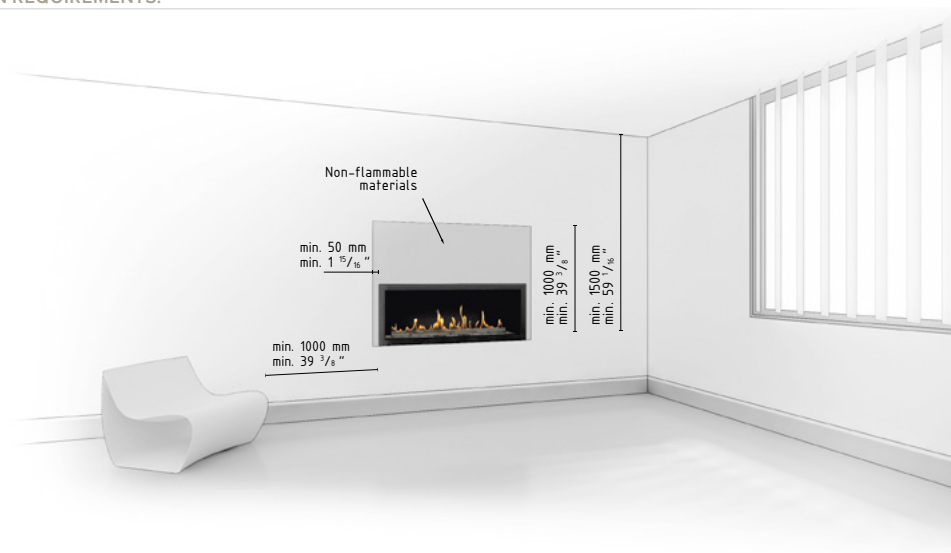

download [PRODUCT INSTRUCTION](#)

[www.PLANIKAFIRES.com](http://www.PLANIKAFIRES.com)